

Intelligent DIN-Rail Input/Output Unit Installation Guide

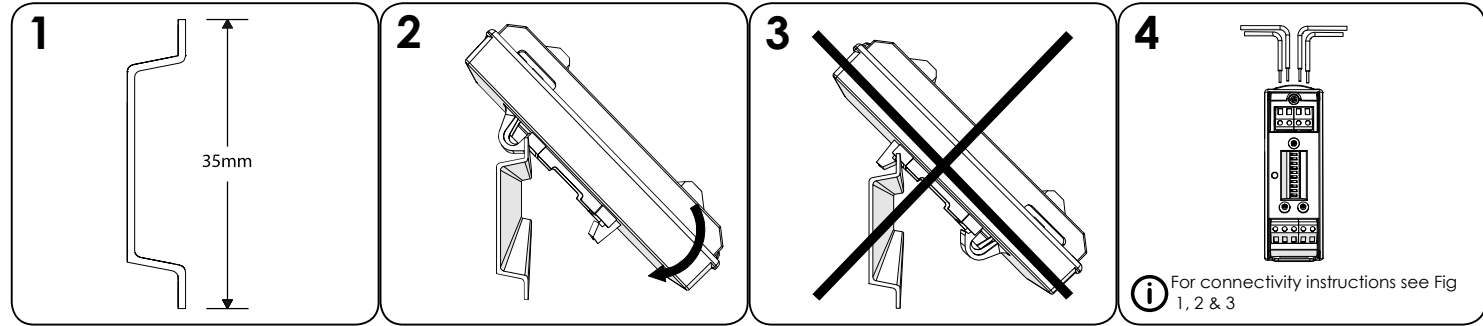

Part No	Product Name
SA4700-302APO	Intelligent DIN-Rail Input/Output Unit

Technical Information

All data is supplied subject to change without notice. Specifications are typical at 24V, 25°C and 50% RH unless otherwise stated.

- Supply Voltage** 17-35V dc
- Quiescent Current** 500µA
- Power-up Surge Current** 900µA
- Relay Output Contact Rating** 1A at 30V dc or ac
- LED Current** 1.6mA per LED
- Maximum Loop Current** 1A
(I_c max; L1 in/out)
- Operating Temperature** -40°C to 70°C
- Humidity** 0% to 95% RH
(no condensation or icing)
- Approvals** EN 54-17 & EN 54-18

For additional technical information please refer to the following documents which are available on request.

PP2559 - Intelligent DIN-Rail Input/Output Unit

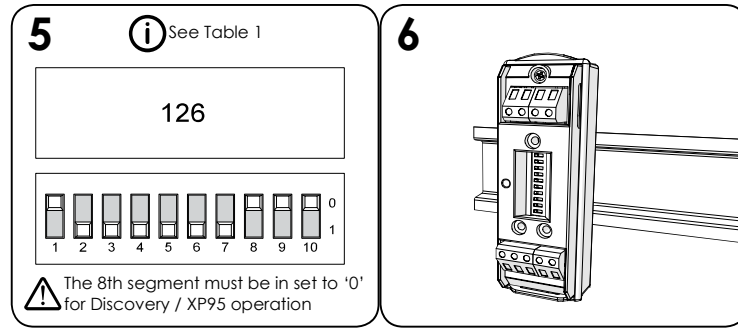

Addressing

Table 1

	XP95 / Discovery Systems	CoreProtocol Systems
Segment	1	Sets the address
	2	
	3	
	4	
	5	
	6	
	7	
	8	Set to '0' (Fault value is returned if set to '1')
FS	Enables failsafe mode (compliant with BS7273-4 for door holders)	
LED	Enables/Disables LED (except Isolator LED)	

Note: On mixed systems addresses 127 and 128 are reserved. Refer to system's panel manufacturer for further information.

Address Setting Examples

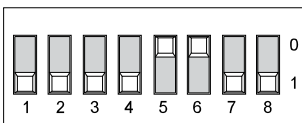
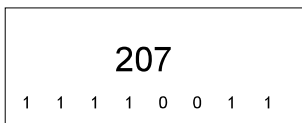
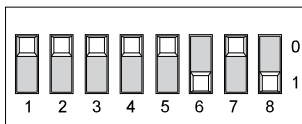
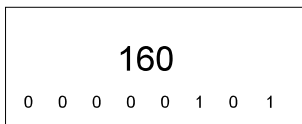
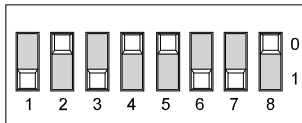
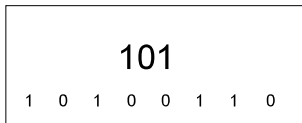
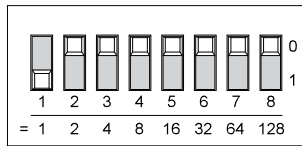

Connectivity Examples

Fig. 1 Standard resistive monitoring mode

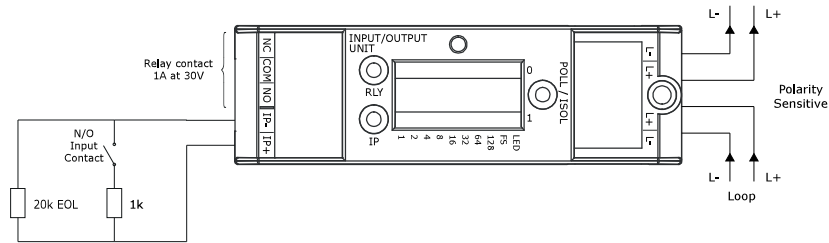

Fig. 2 Normally open monitoring mode (compatible with CoreProtocol only)

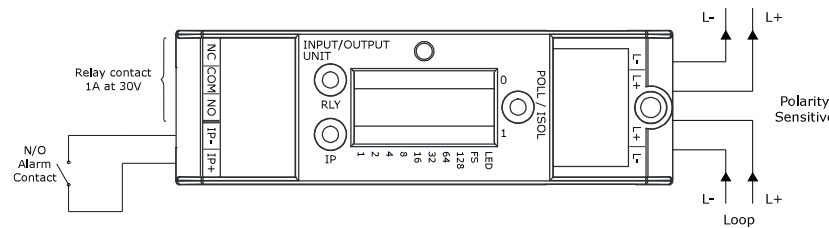
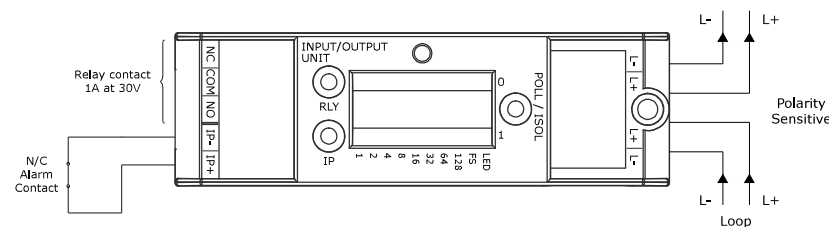

Fig. 3 Normally closed monitoring mode (Compatible with CoreProtocol only)



When operated under XP95 or Discovery Protocols, EN54-13 type 2 devices can be connected. In case EN54-13 type 1 devices need to be connected they must be installed directly next to this module, with no transmission path according to EN 54-13.

LED Status Indicator

RLY	Continuous Red	Relay Active
	Continuous Yellow	Fault
POLL/ISO	Flashing Green	Device Polled
	Continuous Yellow	Isolator Active
IP	Continuous Red	Input Active
	Continuous Yellow	Input Fault

Note:
Not all LEDs can be on simultaneously.

Commissioning

The installation must conform to BS5839-1 (or applicable local codes).

Caution

Unit damage. No electrical supply greater than 50V ac rms or 75V dc should be connected to any terminal of this Input/Output Unit.

Note: For compliance with Electrical Safety Standards the sources switched by the output relays must be limited to a 71V transient over-voltage condition. Contact Apollo for more information.

Troubleshooting

Before investigating individual units for faults, it is important to check that the system wiring is fault free. Earth faults on data loops or interface zone wiring may cause communication errors. Many fault conditions are the result of simple wiring errors. Check all connections to the unit.

Problem	Possible Cause
No response or missing	Incorrect address setting Incorrect loop wiring
Fault condition reported	Incorrect input wiring Relay fails to operate
Relay energised continuously	Control panel has incorrect cause and effect programming Incorrect loop wiring Incorrect address setting
Analogue value unstable	Dual address Loop data fault, data corruption
Constant Alarm	Incorrect wiring Incorrect end-of-line resistor fitted Incompatible control panel software
Isolator LED on	Short-circuit on loop wiring Wiring reverse polarity Too many devices between isolators

Mode Table*

Mode	Description
1	DIL Switch XP Mode
2	Alarm Delays
3	Output and N/O input (can be equivalent for Output only)
4	Output and N/C input
5	Output with Feedback (1st input N/C, 2nd input N/O)
6	Failsafe Output with Feedback (1st input N/C, 2nd input N/O)
7	Failsafe Output without Feedback
8	Momentary Input Activation Sets Output Relay
9	Input Activation Sets Output

*CoreProtocol enabled systems only